AC 2011-1082: AN INEXPENSIVE HANDS-ON INTRODUCTION TO PERMANENT MAGNET DIRECT CURRENT MOTORS

Garrett M. Clayton, Villanova University

Dr. Garrett M. Clayton received his BSME from Seattle University and his MSME and PhD in Mechanical Engineering from the University of Washington (Seattle). He is an Assistant Professor in Mechanical Engineering at Villanova University. His research interests focus on mechatronics, specifically modeling and control of scanning probe microscopes and unmanned vehicles.

Rebecca A Stein, University of Pennsylvania

Rebecca Stein is the Associate Director of Research and Educational Outreach in the School of Engineering and Applied Science at the University of Pennsylvania. She received her B.S. in Mechanical Engineering and Masters in Technology Management from Villanova University. Her background and work experience is in K-12 engineering education initiatives. Rebecca has spent the past 5 years involved in STEM high school programs at Villanova University and The School District of Philadelphia. Additionally, she has helped coordinate numerous robotics competitions such as BEST Robotics, FIRST LEGO League and MATE.

An Inexpensive Hands-on Introduction to Permanent Magnet Direct Current Motors

Abstract

Motors are an important curricular component in freshman and sophomore introduction to mechanical engineering (ME) courses as well as in curricula developed for high school science and robotics clubs. In order to facilitate a hands-on introduction to motors, an inexpensive permanent magnet direct current (PMDC) motor experiment has been developed that gives students an opportunity to build a PMDC motor from common office supplies along with a few inexpensive laboratory components. The novelty of the presented experiment is that it incorporates many aspects of commercially available PMDC motors including, windings, a rotor, bearings, a commutator, and brushes. In this paper, the experiment is presented along with step-by-step instructions showing how to build and troubleshoot the motor. In addition, preliminary experiment testing and student reactions are presented.

1) Introduction

Motors are an important part of the mechanical engineering (ME) curriculum as well as in curricula developed for high school science and robotics clubs – in fact, this experiment was developed as part of a curriculum to accompany the Navy’s SeaPerch program¹, which focuses on junior high and high school students. In college ME programs, motors are introduced in freshman and sophomore introduction to engineering courses, and then elaborated upon in higher level classes, such as system dynamics, control systems, and mechatronics. Most commonly, experiments involving motors focus on reverse engineering products that use them (e.g. power tools) or taking apart motors themselves. This allows students to see how motors work and how they are integrated into common commercial products, however in the author’s experience, this does not always leave students with a deep understanding of how motors work and of the design considerations associated with them. This knowledge gap was evident in student responses to an exam question given after completing a reverse engineering laboratory and a lecture discussing the operation of permanent magnet direct current (PMDC) motors. Students were asked:

“How do PMDC motors work?”

Less than 10% of students gave a satisfactory answer. In order to overcome this issue, a novel inexpensive motor experiment was developed and is presented in this paper. This experiment uses commonly available office supplies (e.g. erasers, paperclips, pencils, rubber bands, etc.) along with a few inexpensive laboratory components (e.g. a pair of magnets and some electrical wire) to construct a fully operational PMDC motor. This experiment has been tested in small groups of students and will be integrated into the sophomore level introduction to ME course at Villanova University – ME2505² in the fall of 2011.

A number of “home-made” motor experiments have been developed for use in high-school science and engineering curricula.^{3,4} These experiments, while well designed and exciting for students, tend to show how physical phenomena that drive motors work, and not how the physical phenomena are harnessed by typical motors to produce motion. For example, one

experiment uses a coil of wire, a battery, a magnet and some paper clips⁴ – see Figure 1. A coil is made from the wire and rotates on bent paperclip bearings. The paperclip bearing also serve a brushes – these connect the battery to the coil while still allowing rotation. As current travels through the coil, a force is applied to the coil due to the magnetic field, causing rotation. In order to keep the coil from stalling, half the wire jacket is removed from the portion of the wire contacting the paperclip bearings/brushes – see magnified area in Figure 1. This stops the current from flowing for half of each rotational cycle, allowing for continuous motion – this is the motor’s commutator.

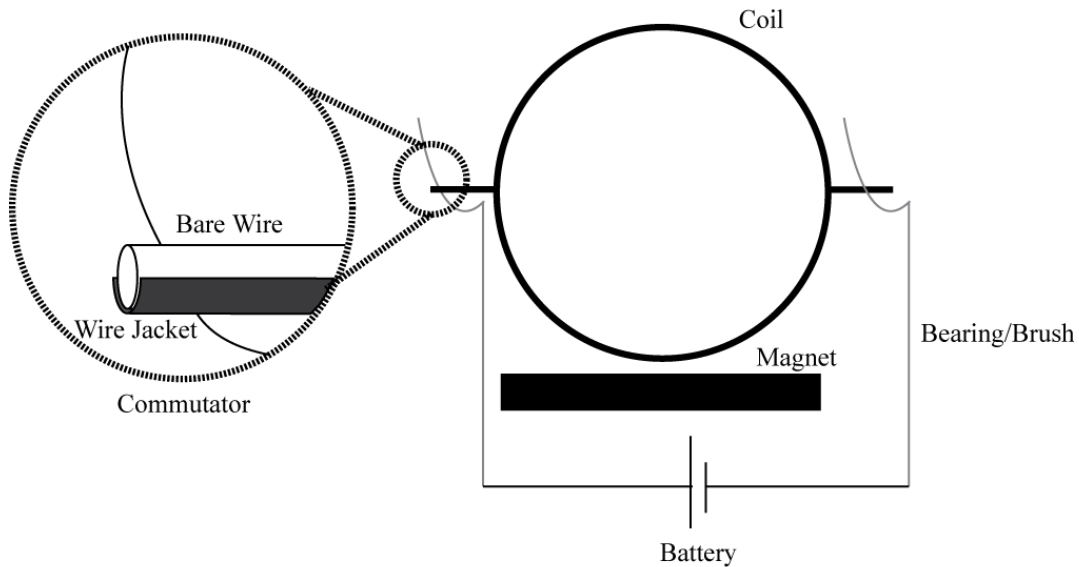

Figure 1: Example motor experiment.

This experiment shows many of the components of a typical PMDC motor, but does not show how a commercial PMDC motor is constructed. Thus students see how the physical concepts behind motors work, but do not see how actual motors are put together.

In the remainder of the paper, a short introduction to DC motors is given, followed by information on experimental supplies and how to build and troubleshoot the DC motor. In addition, results from the preliminary testing are presented.

2) PMDC Motors

The motors that ME students most commonly deal with are electric motors. An electric motor is an electromechanical device that converts electricity into mechanical motion (most commonly rotational motion, but there are linear motors too.) Motors appear quite commonly in consumer products such as hard disk drives, fans, DVD players, VCRs, and air conditioners.

A schematic of a PMDC motor is shown in Figure 2. As can be seen, there are four main motor components: the *magnet*, the *coil*, the *commutator*, and the *brushes*. These components make up the *rotor* (spinning part of the motor – consists of the coils and commutator) and the *stator* (stationary part of the motor – consists of the brushes and magnets).

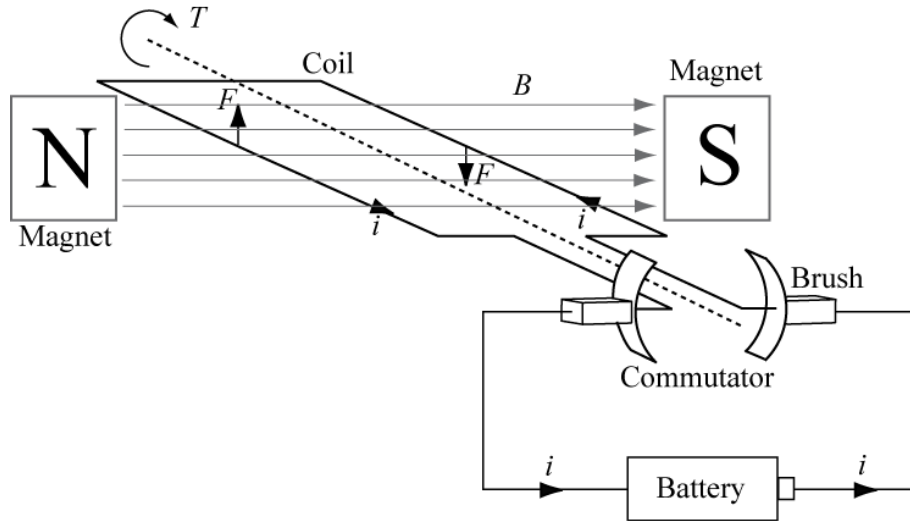

Figure 2: Simplified schematic of the internal parts of a PMDC motor.

The magnet and coil enable the conversion of electrical energy into mechanical energy. As current i (from the battery) flows through a magnetic field B , a force F is applied to the coil,

$$\vec{F} = \vec{i}L \times \vec{B},$$

where L is the length of the coil. This results in a torque

$$\vec{T} = 2r(\vec{i}L \times \vec{B}),$$

that spins the motor. Note that r is the distance from the centerline of the rotor to the coil.

The brushes (stationary) and commutator (rotates) serve two purposes. First, they enable transfer of current from the stationary power source (in this case shown as a battery) and the moving coil. Second, they enable continuous rotation of the coil by allowing the current to switch directions – if current direction wasn't changed, the coil would stall.^{5,6} For more information on motor theory, see References 5 and 6.

3) Experiment Setup

The materials required for this motor experiment are shown in Tables 1 and 2. Table 1 shows the materials that are required for each motor and Table 2 shows additional equipment that should be available for students to use while building the motor. It should be noted that that most materials are commonly available office supplies along with a few components that should be available to most teachers (especially at universities or in high school science classes.)

The expected time to build the motor is 35 to 50 minutes.

Table 1: Bill of materials. Note that most materials are commonly available office supplies. Less commonly available equipment can be purchased at Radio Shack.*

Item	Quantity	Notes
Power Source	See Note	The author used 4 AA batteries connected in series, but a 9 V should also work (this has not been tested.) Can also use a DC power supply.
Drinking Straw	1	Straight straws (i.e. not bendy) are preferred. Can replace with a pencil.
Erasers	2	
Pill Bottle	1	Can replace with other light cylindrical object approximately 1" in diameter.
Insulated Copper Wire	1	Radio Shack: 315-Ft. Magnet Wire Set Model: 278-1345 – cost \$6.99.* Can also use standard solid core copper wire.
Magnets	2	Radio Shack: High-Energy Ceramic Magnet Model: 64-1877 – cost \$1.99.*
Paper Clips- Metal, Large	6	Do not use coated paperclips, bare metal only.
Thin Rubber Bands	10	
Tape	1	Electrical tape or similar.

Table 2: Useful equipment.

Item	Notes
Multimeter	Not required – Useful for troubleshooting the motor Can be purchased at Radioshack: RadioShack 15-Range Digital Multimeter Model: 22-182 – cost 19.99*
Drill with ¼" Bit	
Alligator Clips	
Sand Paper	Required to remove wire insulation if using magnet wire.
Wire Strippers	

* Costs taken from www.radioshack.com on 01/18/2011.

4) Experiment Steps

Given the components from Table 1, the motor can be put together in two subsystems, the rotor – coil and commutator – and the stator – *bearings* (used to hold up the rotor) and brushes. If this experiment is assigned in groups, these subsystems can be put together independently. Each of these subsystems is constructed as follows:

4.1) Building the Rotor

Step 1: Put a hole in both ends of the pill bottle that has a diameter just smaller than the diameter of the straw. (Use ¼ in drill bit and widen if necessary) – see Figure 3 a).

Step 2: Put four notches in the top (pill bottle cap) and bottom of the pill bottle with the wire strippers – the notches should be 90 degrees apart. Make sure the notches are clear of plastic debris – see Figure 3 b) and c). These notches will be used as guides for the coils.

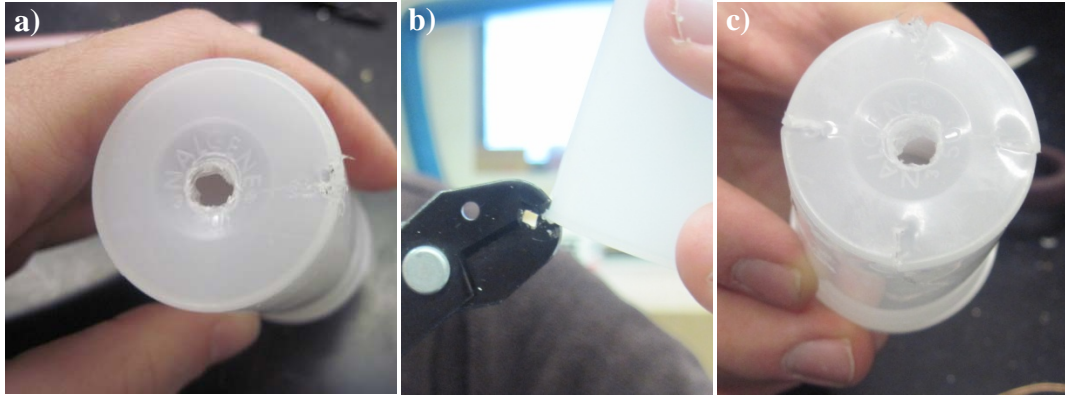

Figure 3: a) Step 1 – drilled pill bottle. b) and c) Step 2 – notches.

Step 3: Push the straw through the holes in the film canister. Leave a slightly longer length of straw on one end – see Figure 4.

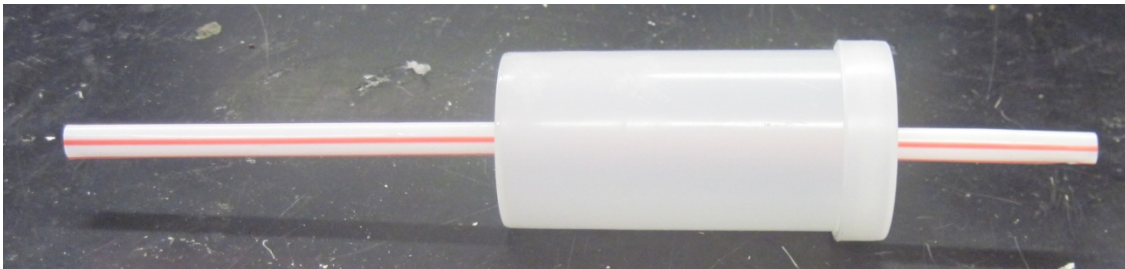

Figure 4: Step 3 – straw/pill bottle assembly.

Step 4: Leaving the wire attached to the spool, strip 2 inches of insulation from the end of the wire – if using plastic coated magnet wire, sand off the plastic coating. Note: If the insulation is not removed, no current will pass through the coil and the motor will not spin. Be careful of wire with clear insulation.

Step 5: Leaving the wire attached to the spool, wrap the wire around the canister using opposite notches – see Figure 5 – the 2 inches of stripped wire should not be wrapped and should be at the long end of the straw – see Figure 6. Note that it is helpful to alternate wrappings on either side of the straw – see Figures 7, 8, and 9 for examples. The number of wraps will determine the torque on the motor. You will need at least 15 wraps.

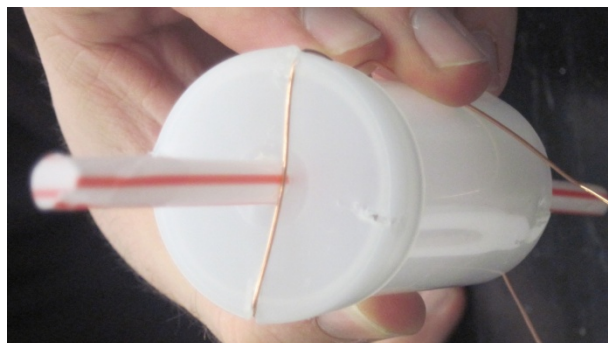

Figure 5: Step 5 – wrapping the wire.

Step 6: When you have enough wraps, cut the wire about 2 inches longer than you need – see Figure 6 a). Strip the insulation off the two extra inches of wire. Tape the ends down near the extra wire with electrical tape – see Figure 6 a). This is a coil on the rotor – see Figure 6 b).

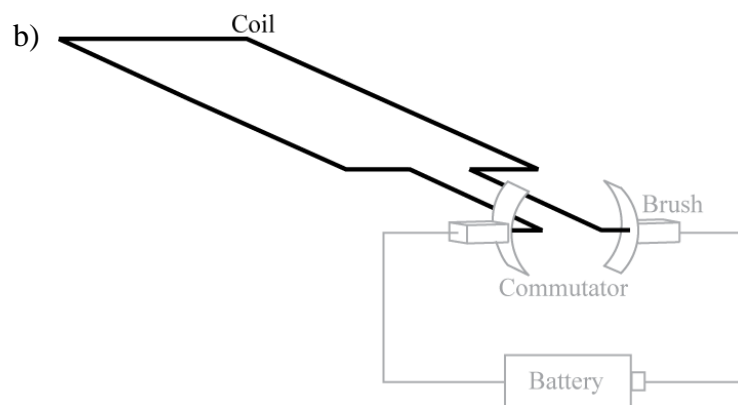
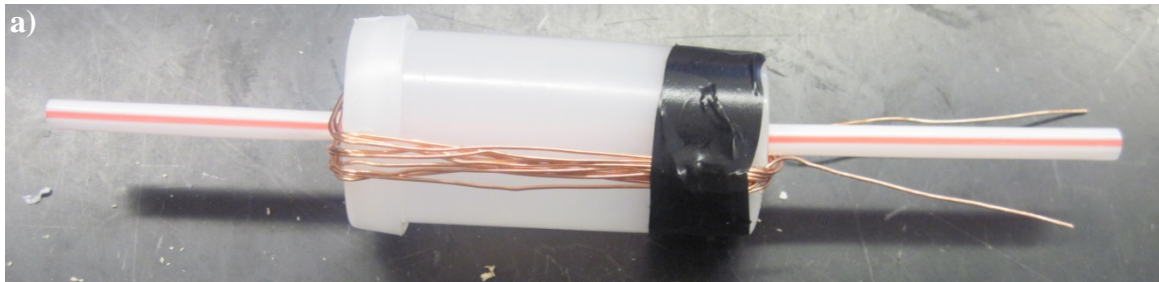

Figure 6: a) Step 6 a motor coil. b) Motor schematic showing a coil.

Step 7: Repeat steps 4-6 for the other set of notches – The result is shown in Figure 7. Note that motors often include multiple coils to make sure that the force is even throughout the rotation. As the motor spins, there are times when force is not being applied, with just one coil, this time is much longer than with 2 or more.

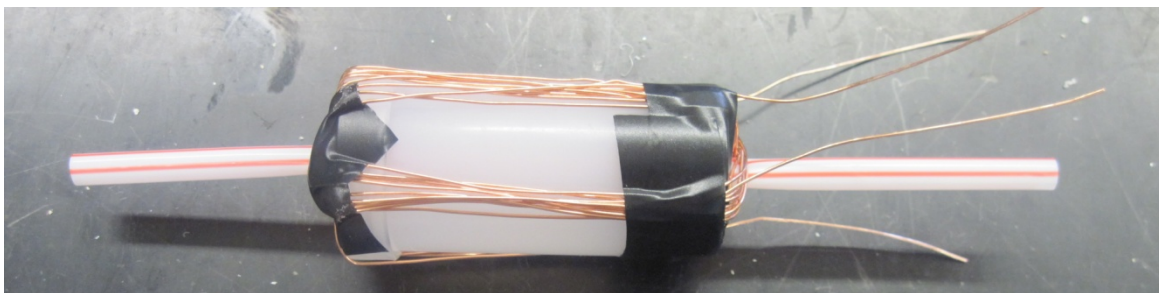

Figure 7: Step 7 – Completed motor coils.

Step 8: Use a rubber band to hold the exposed wire to the straw. The wires should line up with their respective coils – see Figure 8. This wire will make the commutator (which passes current from the brushes to the coils). Note that thin pieces of tape can replace the rubber bands.

Step 9: Trim off the ends of the coils so that there is a ½ inch clearance from the end of the straw – see Figure 8.

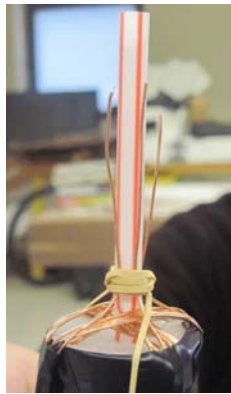

Figure 8: Steps 8 and 9 – making the commutator.

Step 10: Use another rubber band (or thin piece of tape) to secure the end of the wires to the straw – see Figure 9. The rotor (with commutator) is now complete.

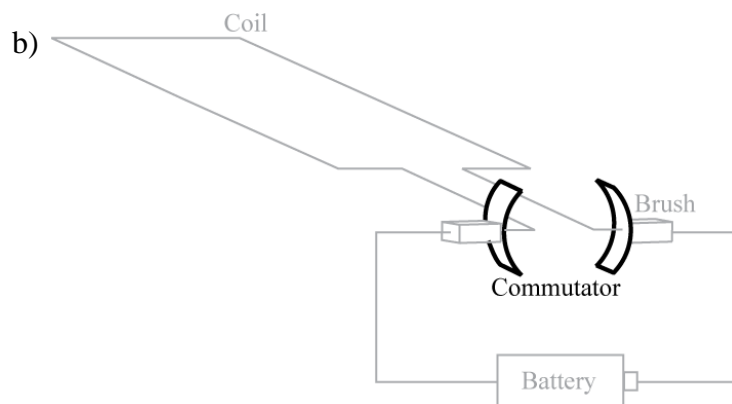
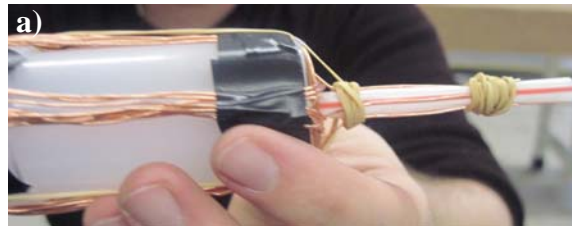

Figure 9: a) Step 10 – the completed commutator. b) Motor schematic showing a commutator.

Step 11: If a multimeter is available, test the wires to determine which strips are connected to one another. You can use the multimeter to check for resistance – connected wires have a low resistance and disconnected wires have a high resistance. Connected wires should be on opposite sides of the straw.

4.2) Building the Stator

Step 1: Take the paper clips and stretch them out so they are straight.

Step 2: Bend two paper clips to form the bearings (supports) for the motor. Feel free to use your imagination in the design. The two paper clips should be identical – See Figure 10 a) for an example. Make sure the opening is large enough to fit the straw.

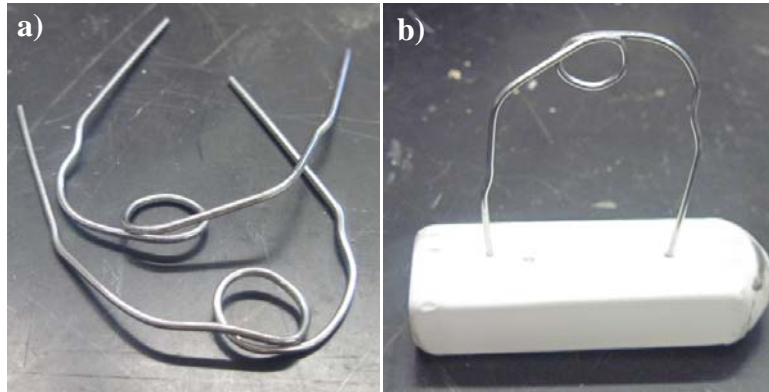

Figure 10: a) Step 2 – making the bearings. b) Step 3 – attaching the bearings.

Step 3: Push the ends of the paper clip bearings into the erasers – See Figure 10 b).

Step 4: The other two paper clips will be the battery hookups and brushes (connect the battery to the coil.) Bend the two paper clips to form an “L.” The lower part of the “L” should be about 1.5 times the width of the erasers – see figure 11.

Step 5: Push both “L” paper clips through the same eraser so that the long part of the “L” sticks up next to the bearing. There should be a small a separation between the two paper clips a little larger than the diameter of the straw. The paper clips should go all the way through the eraser, so there is exposed metal poking through the other side of the eraser – See Figure 11 b).

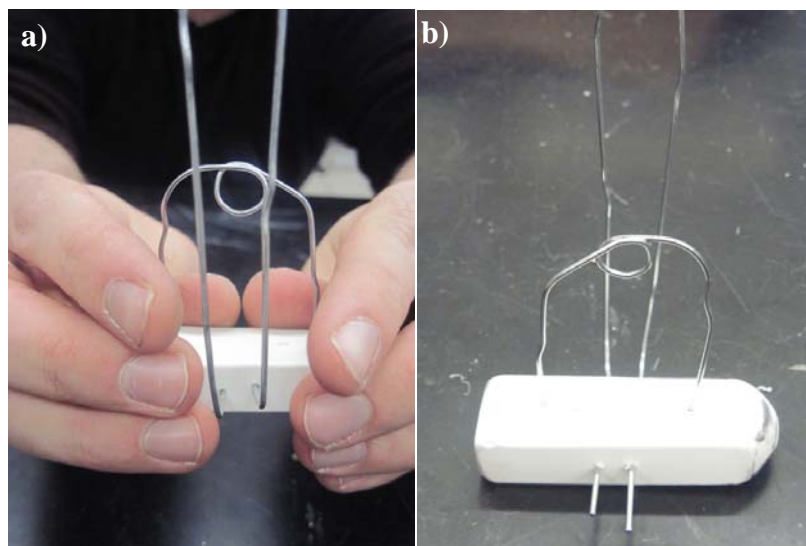

Figure 11: Step 5 – making the brushes. a) The brushes and b) the power connection.

Step 6: Use two other paper clips to attach the sides of the two erasers – the distance between the two erasers should be less than the length of the straw – See Figure 12.

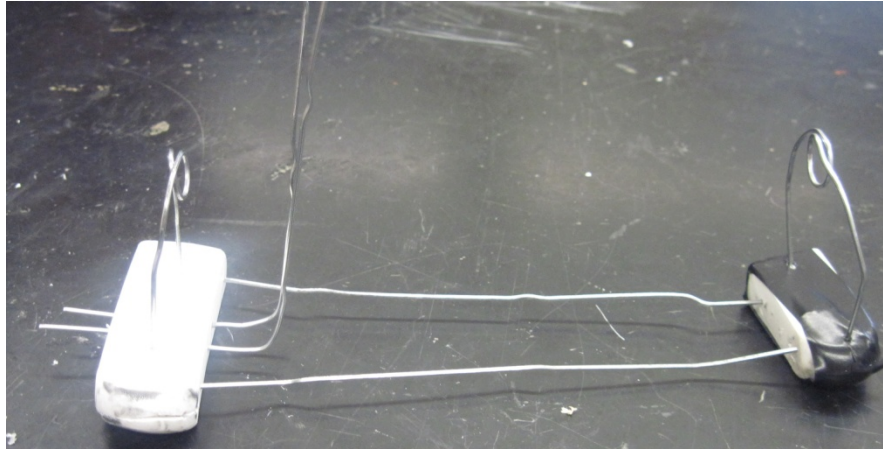

Figure 12: Step 6 – finalizing the stator.

Step 7: Finally, take a rubber band, cut it, and tie it around the two paper clips – See Figure 13. You will adjust how tight the rubber band is when the rotor is added to make sure the brushes (paperclips) contact the commutator (exposed wire).

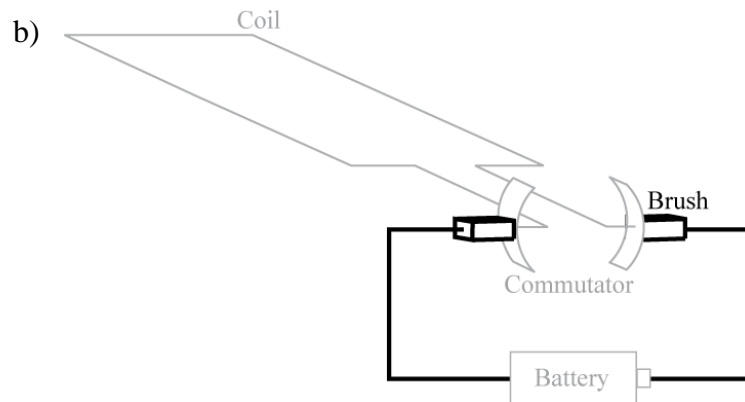
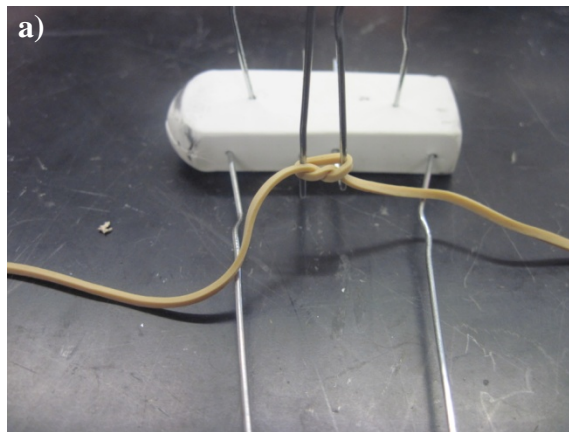

Figure 13: a) Step 7 – finalizing the brushes. b) motor schematic showing the brushes.

4. 3: Motor Assembly

Step 1: Insert the rotor through the holes in the paperclips (bearings) – see Figure 14.

Step 2: Tighten the rubber band until the straightened paperclips (commutator) make contact with the commutator (exposed wire) – See figure 14. It should be loose enough to spin, but not so loose that contact is lost. Test by spinning the shaft to make sure it is not sticking at any point.

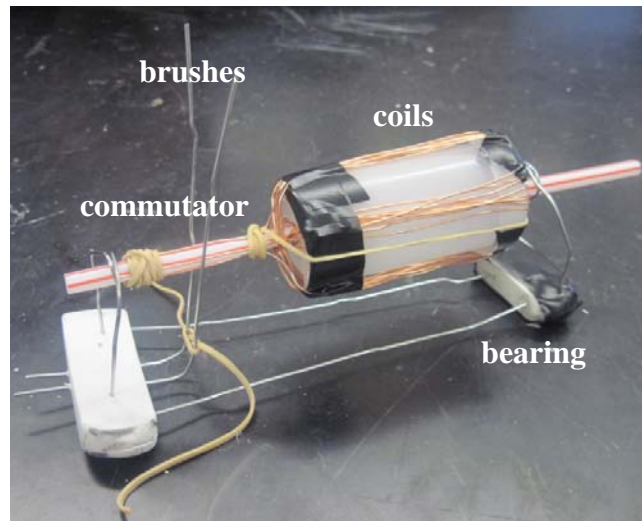

Figure 14: Final motor assembly.

Step 3: Connect the battery to the power terminals on the side of the motor using the alligator clips.

Step 4: Hold the magnets around the rotor – See figure 15. You will need to manually start the motor by spinning the rotor. Make sure to try both directions. Note that you should be able to feel forces pushing on the magnets as the motor spins.

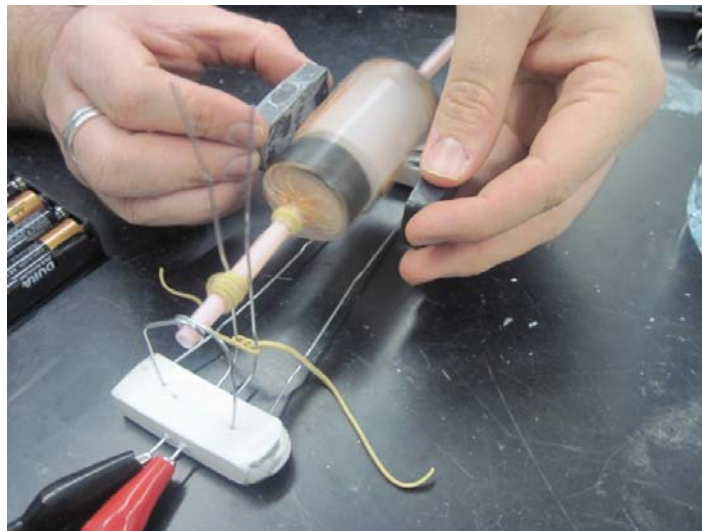

Figure 15: Spinning motor.

4.4) Troubleshooting

It should be noted that these motors do not always spin on the first try. Below are a number of troubleshooting techniques that should get every motor in the class spinning.

- Loosen the brushes (paperclips tied with the rubber band) – Often the paperclips can bind the rotor. It is important to not loosen so much that the connection is lost between the brushes and the commutator (exposed wire on the straw).
- Test the commutator/brushes – With the battery unhooked, attach a multimeter, set to measure resistance (Ω), across the brushes. Slowly spin the rotor. You should see the resistance fluctuate between large (when the brushes are not touching the commutator) and small (when the brushes contact the commutator). This fluctuation should happen 4 times per revolution. If you do not see this, either tighten the rubber band on the brushes, or strip the commutator wires again.
- Test the coils – The resistance of the coils should be small (in the 1 to 5 Ω range). If it is very large, then the insulation at the ends of the coils (on the commutator) needs to be stripped.
- Test the batteries – If the motor will still not spin, make sure that the batteries are not dead.
- As a last resort, you can rewrap the rotor with more wraps. This will increase the force on the rotor.

4.5) Extending this experiment

There are many possible variations to the experiment to show different motor design considerations. For example, the magnets can be pulled away from the device to vary the magnetic field and the alligator clips can be switched on the battery terminals to vary the rotation direction. This enables students to not just learn the different parts of a motor, but to learn design considerations as well.

5) Testing and Assessment

Preliminary testing and assessment of the experiment was conducted on a small group of ME students (6 total students, 3 juniors, 1 senior, and 2 grads). The goal of this was to get feedback on the experimental write-up (these have been incorporated) and to get some preliminary assessment results.

Before beginning the assessment, they were asked to write down how a PMDC motor works. These students have studied DC motors throughout their curriculum, so they scored above average (the average was 3.3/5).

The students were then given the materials and a previous version of this paper and asked to follow the instructions for building the motor. Note that they were given very little help in constructing the motor, aside from clarification of the instructions – these clarifications were recorded and used to improve the steps above. Motor construction took between 35 and 50 minutes. Overall, the students were very excited about performing this experiment, especially when the motor was actually spinning.

When complete the students were asked again to write down how PMDC motors work. Written answers showed significantly improved insight into how PMDC motors are assembled – this resulted in an increase in average score to 4/5. Note that this remaining lack of knowledge was addressed by adding a short theory section at the beginning of this paper.

Finally students were asked,

“Do you feel that this experiment helped you understand DC motors more than before.”

Sample responses were:

- “Before the experiment, I almost completely forgot how a DC motor works. The experiment not only refreshed my memory but also gave me a new insight on how the rotor actually spins when I was holding the magnets and feeling the pulses from the coils”.
- “Yes. It allowed me to see each of the parts and really know what each part is doing. Before this I had what I believe to be a good understanding, but this allowed me to physically see what each part is, and better my understanding that way”.
- “I do feel that the experiment helped my understanding of how a motor functions, I had a general idea of how it did before so, but this cleared up a few details I was unsure of. Specifically, I originally didn't grasp the concept of having more than the two plates on the commutator (I didn't realize how the loops were separated and oriented) but now it makes a lot more sense.”
- It did. I've always been a little confused about the way in which the current was passed onto coils in a way that would create continuous motion. Seeing it in action actually cleared that up for me really well.”

These responses show that, even in these students, who had a good understanding of motors, they were able to clarify some misunderstandings, and gain a better understanding of how PMDC motors work. In the future, a more wide-spread and detailed assessment will be carried out in a classroom setting.

6) Conclusion

Motors are an important curricular component in most freshman and sophomore introduction to ME courses. In order to facilitate a hands-on introduction to motors, an inexpensive PMDC motor experiment was presented in this paper. It was developed to give students an opportunity to build a PMDC motor from common office items along with a few inexpensive components. The novelty of the presented motor experiment is that it incorporated all aspects of a typical PMDC motor including, a commutator and brushes. Complete assembly instructions and preliminary testing/assessment results were presented.

Acknowledgments

Project sponsored by ONR Grant No. N00024-07-C-4212 (monitor: Mr. Marc Steinberg). This financial assistance is gratefully acknowledged.

References

1. J. C. O'Brien, R. A. Stein, G. M. Clayton, A. P. Wemhoff, and C. Nataraj." Exchange – SeaPerch/MATE Science Learning Modules." 2011 ASEE Annual Conference and Exposition.
2. G. M. Clayton, J. O'Brien, K. Kroos, and A. Fleischer. "Introduction to Mechanical Engineering – A Hands-On Approach." 2010 ASEE Annual Conference and Exposition.
3. R. Hoadley. "DC Motors". www.coolmagnetman.com. Accessed March 11, 2001. <<http://www.coolmagnetman.com/magdcmot.htm>>.
4. C. M. Palmer. "Beakman's Electric Motor". Accessed March 11, 2011. <<http://home.hiwaay.net/~palmer/motor.html>>.
5. Laboratory for intelligent systems. "Brushed DC Motor Theory". Northwestern University Mechatronics Design Wiki. Accessed March 11, 2011. <http://hades.mech.northwestern.edu/index.php/Brushed_DC_Motor_Theory>.
6. M. Brain. "How Electric Motors Work." www.howstuffworks.com. Accessed March 11, 2011. <<http://electronics.howstuffworks.com/motor.htm>>.